



High-quality Migatronic welding accessories

MIGATRONIC

Contents

Personal safety.....	Page 4
• Clothing.....	Page 4
• Welding gloves.....	Page 5
• Welding helmets.....	Page 6
Non-optical welding helmets.....	Page 6
Goggles.....	Page 6
Optical welding helmets.....	Page 6
Welding helmets with fresh air system.....	Page 9
• Welding filters and magnification lenses.....	Page 11
• Shielding.....	Page 12
• Welding blankets.....	Page 14
Tools.....	Page 15
Fume extraction.....	Page 16
Tungsten grinding.....	Page 18
Pressure regulators.....	Page 20
Parts for pressure regulators.....	Page 23
Starter kits, wearing parts boxes etc.....	Page 25
Chemicals.....	Page 26
Original Migatronc spare parts.....	Page 27
• Multi plugs.....	Page 27
• Dinse plugs.....	Page 27
• Earth clamps.....	Page 27
• Electrode holders.....	Page 27

We reserve the right to make changes to specifications and to make corrections in the event of a misprint.

Have you chosen the right accessories? Always look for the Migatronic brand

We know from experience that welders and their employers attach great importance to safety and quality, also when it comes to welding accessories.

This catalogue provides you with an overview of our range of high-quality welding accessories, designed specifically for the welding trade.

All products have been tested and approved and comply with all relevant safety regulations and standards.

For manuals and safety data sheets, please refer to migatronic.com.

Migatronic accessories provide
WELDING VALUE
during the complete welding process!



Clothing

Personal safety is all-important to prevent weld spatter and grinding sparks from affecting welders' skin and clothes. Equally important are perfect fit and comfort during welding. All of Migatronic's personal safety products carry CE qualification and materials and designs are carefully selected. **Migatronic dresses you in branded clothing from top to toe.**



WELDING JACKET

Lightweight welding jacket in fire-resistant fabric. Designed specifically for the welding industry. Protects against grinding particles and welding spatter. Onesize.

Art. no.81930043



WELDING APRON

Welding apron in split leather with riveted nylon strap and click buckle. Protects against grinding particles and weld spatter. Length 900 mm, width 580 mm.

Art. no.81930015



SKIRT APRON

Skirt apron in split leather with riveted nylon strap and click buckle. Protects against grinding particles and weld spatter. Length 500 mm, width 580 mm.

Art. no.81930018



WELDING HOOD HEAD AND BACK OF HEAD

Welding hood in split leather for protection of head and back of the head during welding and grinding.

Art. no.81910117



WELDING HOOD

Welding hood in fire-resistant fabric for protection of head, neck and shoulders against weld spatter, grinding particles and radiation.

Art. no.81930042



WELDING SLEEVES

Lightweight set of sleeves in fire resistant fabric with elastic and buttons for shoulder fixing. Protects against grinding particles and weld spatter.

Art. no.81930040



LEGGINGS

Leggings in sets of two in split leather with Velcro fastening. Protect shoes against grinding particles and weld spatter.

Art. no.81930036



NECK PROTECTION FOR WELDING HELMETS

Neck protection designed specifically for Migatronic welding helmet. Protects against weld spatter and radiation.

Art. no.81930041



WELDING MAT

Welding mat in leather and split leather. Length 520 mm, width 330 mm.

Art. no.81930010

Welding gloves

Welders' hands are their most important tools! Migatronik welding gloves ensure safe grip and perfect fit and reduce the risk of injury. Compliance with public health legislation concerning chrome-6 contents reduces the risk of allergic reactions.



TIG WELDING GLOVES SIZE 9
Soft goatskin TIG welding gloves with cuffs made of cow-split. Sewn with Kevlar thread. Inside finger seams. Extra reinforced palm. Abrasion-resistant welding gloves with perfect fit for quality welding. Comply with health standards for chrome-6 content. Length 35 cm. Size 9.

Art. no.81930076



TIG WELDING GLOVES SIZE 10
Soft goatskin TIG welding gloves with cuffs made of cow-split. Sewn with Kevlar thread. Inside finger seams. Extra reinforced palm. Abrasion-resistant welding gloves with perfect fit for quality welding. Comply with health standards for chrome-6 content. Length 35 cm. Size 10.

Art. no.81930070



TIG WELDING GLOVES SIZE 11
Soft goatskin TIG welding gloves with cuffs made of cow-split. Sewn with Kevlar thread. Inside finger seams. Extra reinforced palm. Abrasion-resistant welding gloves with perfect fit for quality welding. Comply with health standards for chrome-6 content. Length 35 cm. Size 11.

Art. no.81930071



MIG WELDING GLOVES SIZE 9
Suede MIG welding gloves. Sewn with Kevlar thread. Extra reinforcement for improved grip and wearing properties. Fleece lining and elastic cuffs for perfect fit. Comply with health standards for chrome-6 content. Length 35 cm. Size 9.

Art. no.81930078



MIG WELDING GLOVES SIZE 10
Suede MIG welding gloves. Sewn with Kevlar thread. Extra reinforcement for improved grip and wearing properties. Fleece lining and elastic cuffs for perfect fit. Comply with health standards for chrome-6 content. Length 35 cm. Size 10.

Art. no.81930074



MIG WELDING GLOVES SIZE 11
Suede MIG welding gloves. Sewn with Kevlar thread. Extra reinforcement for improved grip and wearing properties. Fleece lining and elastic cuffs for perfect fit. Comply with health standards for chrome-6 content. Length 35 cm. Size 11.

Art. no.81930075



MIG HEAVY DUTY WELDING GLOVES SIZE 9
Suede MIG welding gloves sewn with Kevlar thread. Air-suspended fleece lining for increased heat resistance. Extra reinforcement for improved grip and wearing properties. Comply with health standards for chrome-6 content. Length 35 cm. Size 9.

Art. no.81930077



MIG HEAVY DUTY WELDING GLOVES SIZE 10
Suede MIG welding gloves sewn with Kevlar thread. Air-suspended fleece lining for increased heat resistance. Extra reinforcement for improved grip and wearing properties. Comply with health standards for chrome-6 content. Length 35 cm. Size 10.

Art. no.81930072



MIG HEAVY DUTY WELDING GLOVES SIZE 11
Suede MIG welding gloves sewn with Kevlar thread. Air-suspended fleece lining for increased heat resistance. Extra reinforcement for improved grip and wearing properties. Comply with health standards for chrome-6 content. Length 35 cm. Size 11.

Art. no.81930073

Welding helmets

Migatronik does not compromise safety. Our welding helmets provide maximum protection of the welder's eyes and face during welding to prevent workplace injuries. The helmets are designed for optimal welding comfort and optics. Our range meets all requirements, from traditional helmets to automatic types with fresh-air systems.

Non-optical welding helmets and goggles



HEADGEAR FOR WELDING HELMET

Headgear for polypropylene welding helmet

Art. no.81910100



MIGA FLIP UP WELDING HELMET

Welding helmet with Flip-up. Equipped with 60 x 110 mm passive welding filter. Supplied with shade 10 filter.

Art. no.81910890



WELDING SHIELD

Small, lightweight PVC hand-shield. Welding glass: 51 x 108 mm. Supplied with shade 10 filter.

Art. no.81910144



2 PCS SWEAT FRONTLETS

Sweat frontlet of imitation leather for fixing on headgear.

Art. no.81910119



GRINDING SHIELD

Grinding shield in clear plexi glass with pivot fittings in head-gear.

Art. no.81910007

VISOR FOR GRINDING SHIELD

Separate visor in plexi glass for grinding shield.

Art. no.81910008



WELDING/GRINDING GOGGLES

Combined welding/grinding goggles with round carborock glass. Fixed grinding goggles and flip-up welding glasses. Glasses can be changed as required. For ø 50 mm glasses.

Art. no.81912005



SAFETY GOGGLES

Sleek, sporty style goggle. Comfortable to wear owing to soft-touch temples and light-weight construction. Full range of vision.

Clear:
Art. no.81912017
Amber:
Art. no.81912018
Tinted mirror:
Art. no.81912019
Shade 3:
Art. no.81912020
Shade 5:
Art. no.81912021

Optical welding helmets

Migatronik Basic ADF

Art. no. 81910605

The Migatronik Basic ADF welding helmet, ideal for hobby, workshop use and light industrial welding, is equipped with ADF (auto darkening) filter and certified according to EN 379, EN 175, EN 166.



Technical data:

- Fully automatic filter (ADF)
- Externally variable shade DIN 9-13, open DIN 4
- Adjustable delay
- Field of view 100 x 41 mm
- Classification 1/1/1/2
- Adjustable sensitivity
- Solar with built-in battery
- Grinding function

Art. no.	Description	No of pcs
81910605	Migatronik Basic ADF	1
81911062	External shielding glass 90 x 110 mm (10 pcs)	1
81911092	Internal shielding glass 47 x 105 mm (10 pcs)	1

Focus ADF

Art. no. 81910900

The Focus ADF welding helmet is ideal for hobby and workshop use and light industrial welding. The helmet features a fully automatic Tru Colour filter and is certified according to EN379, EN175 and EN166.

Technical data:

- Fully-automatic filter (ADF)
- Externally variable shade 9-13
- Adjustable delay
- Field of view 97 x 47 mm
- Classification 1/1/1/2
- Adjustable sensitivity
- Solar
- Grinding function
- Magnification lenses size 51 x 108 mm can be fitted
- Can be fitted with hard hat

Fields of application:

- MMA (electrode)
- MIG/MAG
- TIG (>10amps)
- Grinding

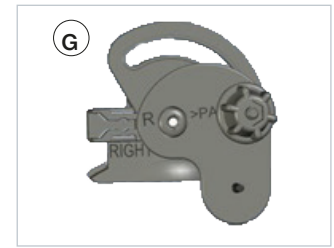
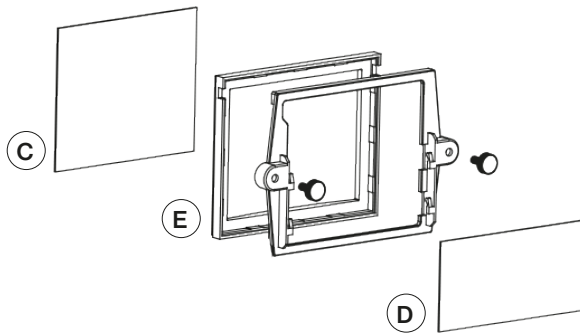
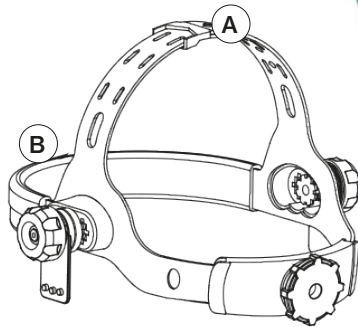

Pos.	Art. no.	Description	No of pcs
	81910900	Focus ADF welding helmet	1
A	81910905	Headgear	1
B	81910906	Sweat frontlet	1
C	81910801	External Shielding Glass 85.9 x 103.6 mm (10 pcs)	1
D	81910802	Internal Shielding Glass 53.7 x 104.8 mm (10 pcs)	1
E	81910904	ADF Mounting Frame Assembly	1
F	81910860	Hard hat	1
G	81910861	Adapter for mounting of hard hat	1

Hard hat

For protection purposes, the Migatronix optical welding helmet Focus ADF and Focus MigADC^{plus} can be equipped with a hard hat with brakes with built-in springs to keep it in place in irrespective of welding position. The heavy-duty construction ensures long life of hard hat and adapter. If the welder stops welding, he can easily dismount the welding helmet, even with welding gloves on, and still be protected by the hard hat.

MigADC^{plus}

The MigADC^{plus} is ideal for welders in the manual and manufacturing industries where technical skills and attention to detail are a must. The MigADC^{plus} provides optimal conditions for welders to produce high-quality welds.

New ADC* technology in the optical filter compensates angular dependence significantly. The flashes of light that welders are exposed to may cause irritation of eyes but the MigADC^{plus} provides full protection at +/-30° visual angle as well as full protection of welders' eye, neck and face movements.

* ADC = Angular Dependence Compensation



Classification: 1/1/1

MigADC^{plus} has achieved the top mark classification for optics, light diffusion, homogeneity and angular dependence.

MigADC^{plus} features:

- Standard or Air model; the latter can be fitted with a fresh-air unit
- Clear field of view from all angles reduces eye fatigue and the need of adjusting functions
- Superior optics
- Aerodynamic design conducts away welding fumes
- External control knobs for adjustment of functions
- TIG mode (DIN 6-8)
- Can be fitted with frame for magnifying lenses
- Can be fitted with hard hat
- 3-year warranty

Technical data:

- Fully-automatic filter (ADF)
- Externally variable shades 6-8 and 9-13
- Externally adjustable delay
- Externally adjustable sensitivity
- External control knob for choosing weld/grind function
- Field of view 96 x 68.5 mm
- Classification 1/1/1/1
- MigADC^{plus} Standard approved according to EN379, EN175, EN166
- MigADC^{plus} Air approved according to EN379, EN175, EN166, EN12941, EN14594.

Fields of application:

- MMA (electrode)
- MIG/MAG
- TIG
- Grinding



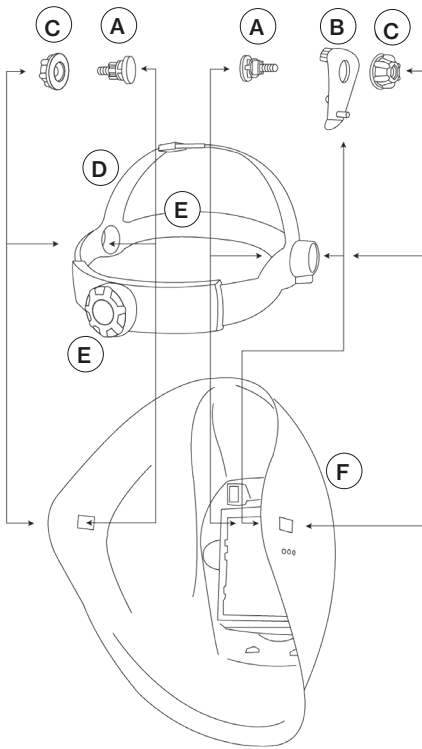

MigADC^{plus} Standard

Art. no. 81910830

Welding helmet with fully-automatic filter (ADF). Externally variable shades 6-8 and 9-13. Externally adjustable delay and sensitivity plus weld/grind function. Perfect for demanding welding jobs in the manual and manufacturing industries. Approved according to EN379, EN175, EN166.

Pos.	Art. no.	Description	No of pcs
	81910830	MigADC ^{plus} Standard	1
A	81910846	Bolt for headgear	1
B	81910845	Brake for headgear	1
C	81910847	Nut for headgear	1
D	81910848	Headgear	1
E	81910844	Sweat frontlet	1
F	81910849	Helmet shell	1
G	81910841	Internal shielding glass 107.5 x 71.5 mm (10 pcs)	1
H	81910850	Frame for magnification lenses	1
I	81911051	Magnification lenses +1.0	1
	81911046	Magnification lenses +1.5	1
	81911047	Magnification lenses +2.0	1
	81911048	Magnification lenses +2.5	1
J	81910840	ADF Grand GDS Plus	1
K	81910842	External shielding glass 147 x 125 mm (10 pcs)	1
L	81910843	Front frame	1
M	81910860	Hard hat	1
N	81910861	Adapter for mounting of hard hat	1

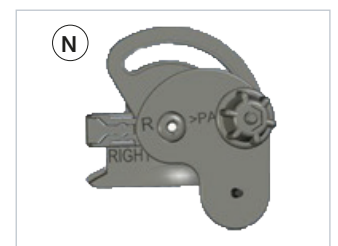
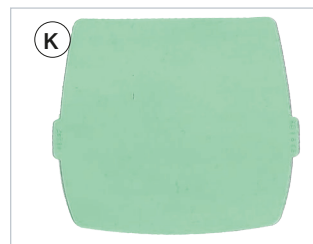
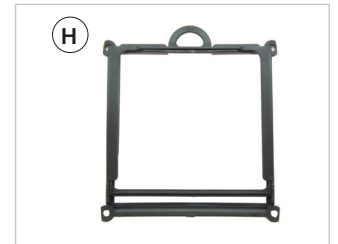
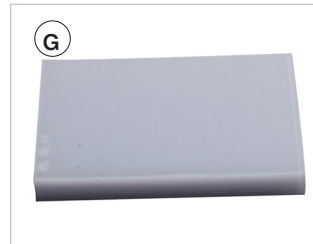

Parts for MigADC^{plus} Standard and MigADC^{plus} Air

Hard hat

For protection purposes, the Migatron optical welding helmet can be equipped with a hard hat with brakes with built-in springs to keep it in place irrespective of welding position. The heavy-duty construction ensures long life of hard hat and adapter. If the welder stops welding, he can easily dismount the welding helmet, even with welding gloves on, and still be protected by the hard hat.

Welding helmets with fresh air system

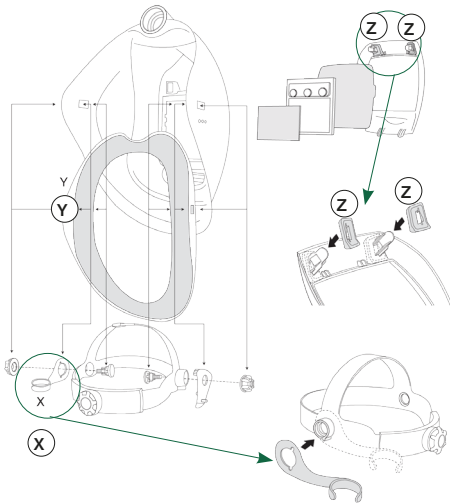

Pos.	Art. no.	Description
	81910835	MigADC ^{plus} Air
X	81910852	Hose holder
Y	81910851	Face seal

Parts for MigADC^{plus} Air only.
See other parts for MigADC^{plus} Air page 8.

MigADC^{plus} Air

Art. no. 81910835

Welding helmet with fully-automatic filter (ADF), featuring the same control facilities and advantages as the MigADC^{plus} Standard. The helmet can be fitted with a fresh-air unit. The integrated air duct with dampers allows the welder to adjust the air flow. Approved according to EN379, EN175, EN166, EN12941, EN14594.



MigADC^{plus} Air with Basic Flow Control



Basic Flow Control



MigADC^{plus} Air with Chemical 3F Flow Control and filter A2P3



Chemical 3F Flow Control

Basic Flow Control

Art. no. 81910875

Motorised respiratory protection system with P3 particle filter. The unit is equipped with a micro-computer that enables a constant flow irrespective of battery size and no matter how much the filter is clogged up. The flow is adjustable from 170 to 240 l/min. Redesigned LED control panel makes all relevant details clearly visible to the welder. Approved according to EN12941/A2-TH3.

Art. no.	Description
81910875	Basic Flow Control
81910309	Prefilter
81910310	Particle filter P3
81910876	Battery
81910879	Air hose
81910878	Belt
81910877	Charger

Chemical 3F Flow Control

Art. no. 81910880

New generation of motorised respiratory protection system, approved according to EN12941/TH2-TH3, EN12942/TM2-TM3 and density class IP65 for use in heavy chemical industries; designed to filter gases, vapours and particles and combinations thereof. The flow is adjustable from 120 to 235 l/min. If the flow falls to a low level or the filter is clogged up, the welder is warned by an alarm in the built-in micro-computer. The unit features a colour display and is supplied with a Li-Ion 14.4V 2.6Ah battery and a charger that charges the battery within 3 hours.

Art. no.	Description
81910880	Chemical 3F Flow Control
81910324	Combination filter A2P3
81910325	Combination filter A2B2E2K2P3 (3 pcs)
81910856	Battery
81910857	Hose
81910859	Belt
81910855	Charger

Welding filters and magnification lenses

Magnification lenses							
Protection	No of pcs	Size mm					
		51 x 108 Art. no.		60 x 110 Art. no.		22 x 108 Art. no.	ø50 Art. no.
DIN 4	10					81911089	
DIN 5	10						81911037
DIN 6	10						81911038
DIN 7	10	81911081		81911082			
DIN 8	10	81911001		81911060			
DIN 9	10	81911007		81911059			
DIN 10	10	81911005		81911058			
DIN 11	10	81911008		81911057			
DIN 12	10	81911006		81911056			
DIN 13	10			81911055			

Protection glass for magnification lenses								
Type of glass	No of pcs	Size mm						
		51 x 108 Art. no.		60 x 110 Art. no.		22 x 108 Art. no.	64 x 101 Art. no.	ø50 Art. no.
Clear shielding glass	10	81911002 (pcs)		81911054 (pcs)				
Clear shielding glass	1							81911035 (pcs)
Clear plexi glass	1	81911045 (10 pcs)		81911053 (10 pcs)		81911003 (10 pcs)	81911061 (10 pcs)	
Yellow plexi glass	1					81911087 (10 pcs)		
Green Plexi glass	1					81911004 (10 pcs)		

Magnification lenses for welding helmets

Magnification lenses that suit most optical welding helmets e.g. Focus ADF and MigADC^{plus} and non-optical welding helmets.



Art. no.	Diopter	Size mm	No of pcs
81911051	+1.0	51 x 108	1
81911046	+1.5	51 x 108	1
81911047	+2.0	51 x 108	1
81911048	+2.5	51 x 108	1

Protection glasses for old models of optical Migatronic welding helmets



Art. no.	Placement	Size mm	No of pcs	Type of helmet
81910801	External	85,9 x 103,6	1	Focus green (second version)
81910802	Internal	53,7 x 104,8	1	Focus green (second version)
81910585	External	94,3 x 114,8	1	Focus black and green (first version)
81910586	Internal	53,4 x 105,7	1	Focus black and green (first version)
81910591	Internal	47 x 103,5	1	Protector ADF
81910106	Internal	51 x 107	1	Protector Three, 4,5/450/451, 5/500/501, 5Exclus.
81910107	External	97 x 110	1	Protector 4/400/401, 4,5/450/451, 5/500/501, 5TM/500TM/501TM, 5Exclus.
81910418	Internal	66 x 109	1	Protector 5/500/501
81911062	External	90 x 110	1	Protector 4/400/401, 5/500/501

Shielding

A safe working place is a matter of common interest to both welders and their employers. Welders and others risk exposure to the harmful UV radiation as well as sparks and metal chips from welding, grinding and cutting. Migatronic's approved shielding products reduce this risk considerably and provide optimal protection for everyone.

Migatronic welding curtains are DIN approved and meet the requirements of EN 1598 and DIN 21404, part 2.

Migatronic welding curtains and strip curtains protect against every kind of UV radiation up to 560 nm.

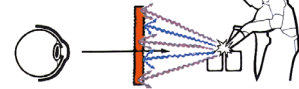

Migatronic welding curtains and strip curtains carry EN-1598CE qualification and Migatronic quality stamp.



Orange:
Shielding during arc welding



Bronze:
Shielding during arc welding

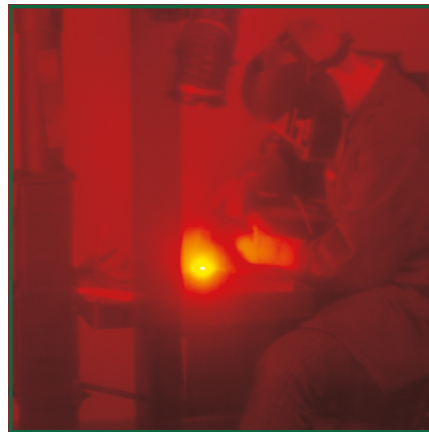

Green (non-transparent):
Shielding during arc welding



Welding curtains

Separate curtains in standard sizes. Ring holes at 22 cm spacing at the top. Plastic snap fasteners welded on the sides. Supplied with 7 metal rings.

	Dull green Non-transparent	Orange Transparent	Bronze (Brown) Transparent
Height x width	Art. no.	Art. no.	Art. no.
1600 x 1400 mm	81910158	81910155	81910152
1800 x 1400 mm	81910159	81910156	81910153
2000 x 1400 mm	81910160	81910157	81910154

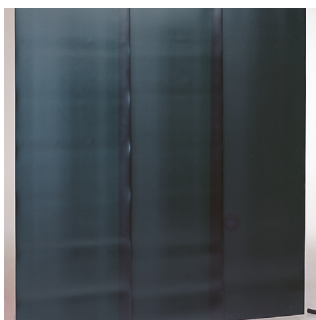

Strip curtains

Design a welding cabin that suits today's requirements and redesign it tomorrow. Strip curtains with 1.0 mm thick strips are a simple and flexible solution. Large workpieces can easily be passed through the curtains, and in the case of damage it is enough to replace the damaged strip(s). Supplied in boxes of 4.

		Dull green Non-transparent	Orange Transparent	Bronze (Brown) Transparent
Height x width	Qty	Art. no.	Art. no.	Art. no.
1600 x 570 mm	4	81910163	81910166	81910169
2000 x 570 mm	4	81910165	81910168	81910171



MOBILE WELDING CURTAIN DULL-GREEN
 Mobile, flexible welding curtain with 2 pivoting arms allows you to make either a booth or an extended curtain. The stand is supplied with 1.0 mm thick dull-green, non-transparent strips.

Width: 3750 mm.
 Height: 2000 mm.

Art. no.81910394



MOBILE WELDING CURTAIN ORANGE

Mobile, flexible welding curtain with 2 pivoting arms allows you to make either a booth or an extended curtain. The stand is supplied with 1.0 mm thick orange, non-transparent strips.

Width: 3750 mm.
 Height: 2000 mm.

Art. no.81910395



WELDING CURTAIN GREEN INCL. STAND

Mobile welding curtain incl. galvanised stand. Dull-green, non-transparent. Width 2000 mm. Height 2000 mm.

Art. no.81910150



WELDING CURTAIN ORANGE INCL. STAND

Mobile welding curtain incl. galvanised stand. Orange, transparent. Width 2000 mm. Height 2000 mm.

Art. no.81910151

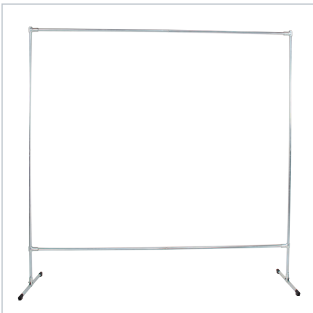

SEPARATE STAND FOR MOBILE WELDING CURTAIN

Galvanised stand for mobile welding curtain. Fits also 4 welding curtain strips size 1600 x 570 mm.

Art. no.81910396



METAL RING FOR CURTAINS

Metal ring for mounting of welding curtains and strip curtains e.g. on galvanised stand.

Art. no.81910210

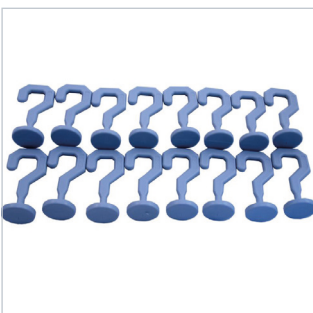

PLASTIC HOOKS FOR SLIDING RAIL, PACKAGE OF 16

Plastic hooks for mounting welding curtains and strip curtains in C-profile sliding rail.

Art. no.81910211



SLIDING RAIL C-PROFILE

Galvanised sliding rail in C-profile. Measurement: 30 x 35 x 1.5 mm (max. 6 m).

Art. no.81910356

Build your personal welding cabin

Migatronic shielding elements allow you to design a welding cabin that suits your requirements.

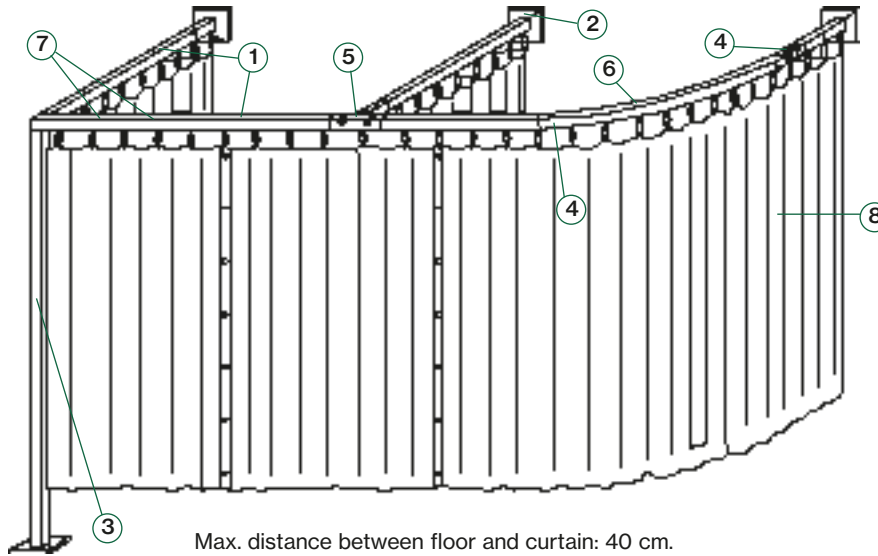

Pos.	Description	Art. no.
1	Sliding rail C-profile. Dimensions: 30 x 35 x 1.5 mm (max. 6 m)	81910356
2	Wall fittings for C-profile	81910241*
	Angle brace	81910350*
	Holder for C-profile	81910351*
3	Galvanized support with foot plate for C-profile	
	Height: 225 cm	81910353*
	Height: 285 cm	81910354*
4	Galvanized rail fittings for C-profile	81910357*
5	Galvanized T-piece connecting C-profiles	81910352*
6	Galvanized 90° bend, radius 500 mm for C-profile	81910355*
7	Plastic sliding rails for C-profile (16 pcs.)	81910211
8	Curtain, see page 12	

Your personal welding cabin can be pieced together of:

- made-to-measure curtains
- curtains with snap fasteners
- strip curtains

* Please allow for extended delivery times.

Welding blankets



WELDING BLANKET KRONOS 2 X 1 M
 Universal glass tissue welding blanket. Single-sided PU coating. Heat-resistant up to 550°C. Suitable for light welding and grinding.

Art. no.81930060



WELDING BLANKET KRONOS 2 X 2 M
 Universal glass tissue welding blanket. Single-sided PU coating. Heat-resistant up to 550°C. Suitable for light welding and grinding.

Art. no.81930061



WELDING BLANKET KRONOS 25 X 1 M
 Universal glass tissue welding blanket. Single-sided PU coating. Heat-resistant up to 550°C. Suitable for light welding and grinding.

Art. no.81930062

Tools

A few tools make welders' work a lot easier. Professional Migatronik tools make it easy for welders to clean, check and make the finishing touches to workpieces.



NOZZLE TONG Ø12-15 MM
Nozzle and wire cutter for cleaning ø12-15 mm gas nozzles as well as quick and correct wire cutting.

Art. no.81940010



NOZZLE TONG Ø15-18 MM
Nozzle and wire cutter for cleaning ø15-18 mm gas nozzles as well as quick and correct wire cutting.

Art. no.81940011



LARGE NOZZLE TONG
Nozzle and wire cutter for cleaning large gas nozzles as well as quick and correct wire cutting.

Art. no.81940028

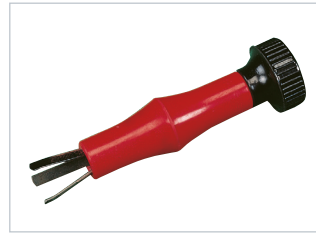

GAS NOZZLE CLEANER
Gas nozzle cleaner with leaf springs for all types of gas nozzles. Removing weld spatter increases life of gas nozzles.

Art. no.81940012



MITRE MAGNET 1 X 300 KG
Mitre magnet for 30°, 45°, 60°, 75° and 90°. Retaining power 1 x 300 N.

Art. no.81080003



MITRE MAGNET 1 X 450 KG
Mitre magnet for 30°, 45°, 60°, 75° and 90°. Retaining power 1 x 450 N.

Art. no.81080005

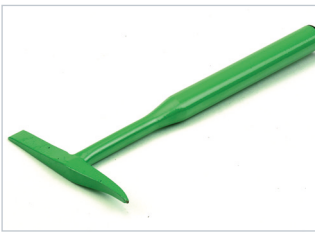

CHIPPING HAMMER
Chipping hammer with metal handle. Weight 415 g.

Art. no.81920003



WIRE BRUSH FOR STAINLESS STEEL AND ALUMINIUM
Wire brush for cleaning stainless steel and aluminium workpieces.

Art. no.81940020



WELDING MIRROR WITH FLEXIBLE ARM
Welding mirror with flexible arm. Dimensions 70 x 80 x 1.5 mm.

Art. no.81912202



WELDING MIRROR WITH MAGNETIC FOOT AND FLEXIBLE ARM
Welding mirror with magnetic foot and flexible arm. Dimensions 70 x 80 x 1.5 mm.

Art. no.81912201



MIRROR 1.0 MM (10 PCS.)
Mirror for flexible arm. Dimensions 70 x 80 x 1.0 mm. Supplied in packages of 10.

Art. no.81912204



CLEANING NEEDLES SET
Cleaning needles set consisting of 1 file and 14 short cleaning needles in a metal box. Use of cleaning needles increases the life of welding nozzles and cutting nozzles.

Art. no.81970018

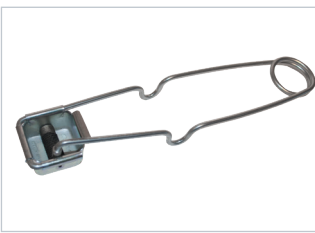

D75/S80 GAS IGNITER
Gas igniter for igniting the gas torch; flexible and with replaceable ignite flint.

Art. no.81970209



IGNITE FLINT (5 PCS.)
Replaceable gas ignite flint for D75/S80 gas igniter. Supplied in packages of 5.

Art. no.81970210

Fume extraction

Welding fume is highly hazardous to health and must be removed from the welding site and subsequently filtered in order to protect our environment. Migatronik takes pride in being as “green” as the welding machines we produce!



MigaVent Mini ^{*)}

Portable, mobile high-vacuum filter unit for short-term welding and grinding assignments where high vacuum extraction is permitted. External air-cooling of motor. Supplied with easily replaceable dust class M filter. Transports up to 209 m³ air/hour. Supplied with ø 50 mm hose connection.

Technical data:

- Noise level: 73 dB (A)
- High-vacuum dust class M filter
- 1 x 230 V
- 1200 Watt
- ø50 mm connection
- Weight: 18.7 kg
- Dimensions (L x W x H): 370 x 350 x 534 mm

Art. no. 82031200

^{*)} Additional schuko plug is required



MOUTH PIECE 200 MM Ø50 MM
200 mm slot nozzle with steel hose and magnet for mounting on 51 mm flex hose.

Art. no.82031201



MOUTH PIECE 300 MM Ø50 MM
300 mm slot nozzle with magnet for mounting on 51 mm flex hose.

Art. no.82031202



MOUTH PIECE ROUND Ø50 MM
Conic extraction mouthpiece with steel hose and magnet for mounting on 51 mm flex hose.

Art. no.82031203



FILTER FOR MIGAVENT MINI
Fire-resistant filter cartridge for MigaVent Mini

Art. no.82031205



ADAPTER FOR HOSE 50 MM <=> 45 MM
Adapter to connect a 50 mm connection to a 45 mm hose and a 45 mm connection to a 50 mm hose.

Art. no.82031206



EXTRACTION HOSE
Flex extraction hose for MigaVent Mini and mouthpiece in running metre. Inside diameter ø 51 mm.
Art. no. 92570042

Flex extraction hose for MigAir and mouthpiece in running metre. Inside diameter ø 45 mm.
Art. no. 92570041



MigaVent 2000^{*)}

Ventilator for wall-mounting with energy-saving engine. MigaVent 2000 transports up to 1.300 m³ air/h.

Technical data:

- 3 x 400 V
- 50 Hz
- 2780 revolutions/minute
- 1.10 kW
- ø160 mm connection

Art. no.82031230

**) Additional schuko plug is required*



FLEXI EXTRACTION ARM 3 M

3 m extraction arm with swivel link, extraction hood with damper and gas springs. Ø 160 mm hose connection.

Art. no.82031231

FLEXI EXTRACTION ARM 4 M

4 m extraction arm with swivel link, extraction hood with damper and gas springs. Ø 160 mm hose connection.

Art. no.82031232



PRESSURE GUARD

Pressure guard for MigaVent 2000 and Flexi extraction arm. Red warning light is lit in case of insufficient extraction.

Art. no.82031233

Tungsten grinding

Trouble-free TIG welding requires a correctly-ground Tungsten electrode. Migatronik Tungsten grinders provide correctly-ground Tungsten electrodes for perfect TIG welding results and reduce the consumption of electrodes to a minimum for the benefit of the environment.



Migatronik also offers a wide range of high-quality tungsten electrodes and recommends our allround Super Blue™ with excellent ignition and reignition properties for improved welding quality and safety; the optimal choice for DC and AC welding in all types of material.



Green Pointer X2

Handy, portable tungsten grinder for perfect and eco-friendly grinding of 1.0-4.0 mm tungsten electrodes; including exhaust with easily replaceable filter and excenter disc for triple utilisation of diamond disc. Green Pointer X2 is supplied in a transport case complete with diamond grinding disc, electrode holder and electrode clamps for 1.6, 2.4 and 3.2 mm electrodes.

Green Pointer X2 with schuko plug
Art. no.82036170



ELECTRODE CLAMPS
Electrode clamps for Green Pointer X2, Pro and Pro Cut

Art. no.: ø1.0 mm82036173
Art. no.: ø1.6 mm82036174
Art. no.: ø2.0 mm82036175
Art. no.: ø2.4 mm82036176
Art. no.: ø3.2 mm82036177
Art. no.: ø4.0 mm82036178



DIAMOND GRINDING DISC GREEN POINTER X2
Diamond grinding disc for Green Pointer X2 Ø 40 mm.

Art. no.82036171



ELECTRODE HOLDER GREEN POINTER X2
Electrode holder for Green Pointer X2

Art. no.82036172



FILTER CASSETTE GREEN POINTER X2
Filter cassette for collection of grinding dust in Green Pointer X2.

Art. no.82036179



TABLE CONSOLE GREEN POINTER X2
Solid console for fixing the Green Pointer X2 to a table during grinding.

Art. no.82036185



SIGHT GLASS GREEN POINTER X2
Sight glass for Green Pointer X2

Art. no.82036186



Green Pointer Pro

Tungsten wet grinder for grinding 0.8-4.0 mm tungsten electrodes, featuring eco-friendly collection of toxic dust particles. Cold wet grinding combined with high grinding speed provide a smooth surface of the tungsten electrode. Green Pointer Pro ensures correctly-ground tungsten electrodes for trouble-free TIG welding and is supplied complete with console, diamond grinding disc, grinding liquid, electrode holder and electrode clamps for 1.6, 2.4 and 3.2 mm electrodes.

Art. no. 82036220

Green Pointer Pro Cut

Tungsten wet grinding and cutting device for perfect and eco-friendly grinding and cutting 0.8-4.0 mm tungsten electrodes. Green Pointer Pro Cut grinds the electrode tips in exact angles and lengths for TIG welding operations, including robot and orbital welding, and is supplied complete with console, diamond grinding disc, grinding liquid, electrode holder and electrode clamps for 1.6, 2.4 and 3.2 mm electrodes.

Art. no. 82036230



ELECTRODE HOLDER GREEN POINTER PRO/PRO CUT

Electrode holder for Green Pointer Pro and Pro Cut complete with handle and union nut.

Art. no. 82036208



ELECTRODE CLAMPS

Electrode clamps for Green Pointer X2, Pro and Pro Cut
 Art. no.: ø1.0 mm 82036173
 Art. no.: ø1.6 mm 82036174
 Art. no.: ø2.0 mm 82036175
 Art. no.: ø2.4 mm 82036176
 Art. no.: ø3.2 mm 82036177
 Art. no.: ø4.0 mm 82036178



DIAMOND GRINDING DISC GREEN POINTER PRO/PRO CUT
 Diamond grinding disc for Green Pointer Pro and Pro Cut

Art. no. 82036210



GRINDING LIQUID CONTAINER *

Container with cooling/lubricating liquid for tungsten wet grinders Green Pointer Pro, Pro Cut, MK1, MK2. The container collects heavy metals in the grinding particles.

Art. no. 82036132



GRINDING LIQUID *
 Special cooling/lubricating liquid in 250 ml bottles for tungsten wet grinders.

Art. no. 82036103



GRINDING LIQUID *
 Grinding liquid in 5 l cans for tungsten wet grinders.

Art. no. 82036125

* Used liquid is to be disposed of at your local hazardous waste disposal site.

Pressure regulators

A high rate of return for quite a modest investment! Migatronig pressure regulators with incorporated gas saver function will allow you to save up to 50% of your gas consumption. Pressure regulators will also help you to monitor the amount of gas in the cylinder and prevent you from running out of gas during welding. Contact Migatronig if you need other types of thread.

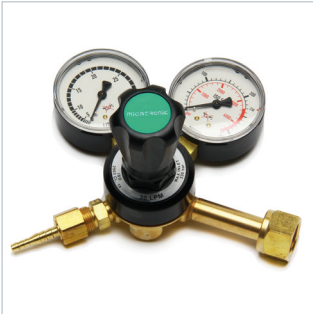

CO₂ PRESSURE REGULATOR 2 MANOMETERS

High-quality and high-capacity CO₂ pressure regulator. Max. 200 bar primary pressure. Equipped with manometer for gas flow read-out. Operating range: 0-35 l/min. Inlet thread: W21.8x14/1" Outlet thread: G3/8"

Art. no.81963034



CO₂ PRESSURE REGULATOR 2 MANOMETERS

High-quality and high-capacity Argon/mix pressure regulator. Max. 200 bar primary pressure. Equipped with manometer for gas flow read-out. Operating range: 0-35 l/min. Inlet thread: R3/4" Outlet thread: G3/8"

Art. no.81963035



ARGON/MIX PRESSURE REGULATOR 2 MANOMETERS

High-quality and high-capacity Argon/mix pressure regulator. Max. 200 bar primary pressure. Equipped with manometer for gas flow read-out. Operating range: 0-35 l/min. Inlet thread: W24.32x14/1" Outlet thread: G3/8"

Art. no.81963038



ARGON/MIX PRESSURE REGULATOR 2 MANOMETERS

High-quality and high-capacity Argon/mix pressure regulator. Max. 200 bar primary pressure. Equipped with manometer for gas flow read-out. Operating range: 0-35 l/min. Inlet thread: W24,52ext Outlet thread: G3/8"

Art. no. 81963004



ARGON/MIX PRESSURE REGULATOR 2 MANOMETERS

High-quality and high-capacity CO₂ pressure regulator. Max. 200 bar primary pressure. With manometer for gas flow read-out. Operating range: 0-35 l/min. Inlet thread: W21,8x14/1" Outlet thread: G1/4"

Art. no.81963348



ARGON/MIX PRESSURE REGULATOR 2 MANOMETERS

High-quality and high-capacity Argon/mix pressure regulator. Max. 200 bar primary pressure. With manometer for gas flow read-out. Operating range: 0-35 l/min. Inlet thread: W21,8x14/1" Outlet thread: M12x1

Art. no. 81963347



FORMIER/H₂ PRESSURE REGULATOR 2 MANOMETERS

High-quality and high-capacity-pressure regulator for formier or H₂.Max. 200 bar primary pressure. With manometer for gas flow read-out. Operating range: 0-16 bar Capacity: 30 m³/h Inlet thread: W21,8x14/1"LH Outlet thread: G3/8"LH

Art. no.81963068



ARGON/MIX REGULATOR 2 MANOMETERS BOTTOM CONNECTION

High-quality and high-capacity Argon/mix pressure regulator. Max. 200 bar primary pressure. With manometer for gas flow read-out. Operating range: 0-35 l/min. Inlet thread: G5/8"ext Outlet thread: G3/8"

Art. no.81963346

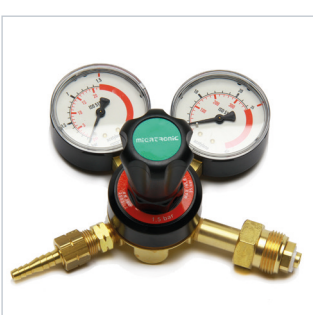

ACETYLENE PRESSURE REGULATOR 2 MANOMETERS

High-quality and high-capacity pressure regulator for acetylene. Max. 40 bar primary pressure. With manometer for gas flow read-out. Operating range: 0-4 bar Capacity: 5 m³/h Inlet thread: G3/4"ext Outlet thread: G3/8"LH

Art. no.81963065

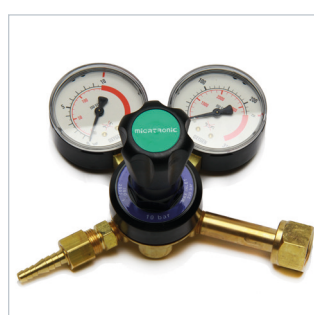

OXYGEN PRESSURE REGULATOR 2 MANOMETERS

High-quality and high-capacity pressure regulator for oxygen. Max. 200 bar primary pressure. With manometer for gas flow read-out. Operating range: 0-16 bar Capacity: 30 m³/h Inlet thread: W21,8x14/1" Outlet thread: G3/8"

Art. no.81963066

Migatronics offers a wide range of pressure regulators, including pressure regulators for central systems.



**ARGON/MIX OPTIMATOR
1 FLOWMETER**
Argon/mix Optimator with built-in gas saver. Gas consumption can be reduced by up to 50%. Result = fewer replacements of gas cylinders and improved production efficiency.
Inlet thread: W24.32x14/1"
Outlet thread: G3/8"

Art. no.81963041



**ARGON/MIX OPTIMATOR
1 FLOWMETER**
Argon/mix Optimator with built-in gas saver. Gas consumption can be reduced by up to 50%. Result = fewer replacements of gas cylinders and improved production efficiency.
Inlet thread: W24,5x14/1"
Outlet thread: G3/8"

Art. no.81963324



**ARGON/MIX OPTIMATOR
1 FLOWMETER**
Argon/mix Optimator with built-in gas saver. Gas consumption can be reduced by up to 50%. Result = fewer replacements of gas cylinders and improved production efficiency.
Inlet thread: W21,8x14/1"
Outlet thread: G1/4"

Art. no.81963047



**ARGON/MIX OPTIMATOR
1 FLOWMETER**
Argon/mix Optimator with built-in gas saver. Gas consumption can be reduced by up to 50%. Result = fewer replacements of gas cylinders and improved production efficiency.
Inlet thread: W21,8x14/1"
Outlet thread: M12x1

Art. no.81963315



**ARGON/MIX OPTIMATOR
1 FLOWMETER BOTTOM
CONNECTION**
Argon/mix Optimator with built-in gas saver. Gas consumption can be reduced by up to 50%. Result = fewer replacements of gas cylinders and improved production efficiency.
Inlet thread: G5/8"ext
Outlet thread: G3/8"

Art. no.81963080



**ARGON/H2 OPTIMATOR
1 FLOWMETER**
Argon/H2 Optimator with built-in gas saver. Gas consumption can be reduced by up to 50%. Result = fewer replacements of gas cylinders and improved production efficiency.
Inlet thread: W21,8x14/1"LH
Outlet thread: G3/8"LH

Art. no.81963048



**ARGON/MIX OPTIMATOR
1 FLOWMETER**
Argon/mix Optimator with built-in gas saver. Gas consumption can be reduced by up to 50%. Result = fewer replacements of gas cylinders and improved production efficiency.
Inlet thread: W21,8x14/1"
Outlet thread: G3/8"

Art. no.81963309



**ARGON/MIX OPTIMATOR
2 FLOWMETRES**
Argon/mix Optimator with 2 flowmetres. Used for shielding gas and back-up gas from the same gas cylinder. Equipped with gas saver. Gas consumption can be reduced by up to 50%.
Inlet thread: W21,8x14/1"
Outlet thread: G1/4"

Art. no.81963050



ARGON/MIX PRESSURE REGULATOR 1 FLOWMETER
 High-quality and high-capacity Argon/mix pressure regulator. Max. 200 bar primary pressure. Equipped with flowmeter for gas flow read-out.
 Operating range: 0-34 l/min.
 Inlet thread: W24.32x14/1"
 Outlet thread: G3/8"

Art. no.81963055



ARGON/MIX PRESSURE REGULATOR 1 FLOWMETER
 High-quality and high-capacity Argon/mix pressure regulator. Max. 200 bar primary pressure. With flowmeter for gas flow read-out.
 Operating range: 0-34 l/min.
 Inlet thread: W24,5x14/1"
 Outlet thread: G3/8"

Art. no.81963320



ARGON/MIX PRESSURE REGULATOR 1 FLOWMETER
 High-quality and high-capacity Argon/mix pressure regulator. Max. 200 bar primary pressure. With flowmeter for gas flow read-out.
 Operating range: 0-34 l/min.
 Inlet thread: W21,8x14/1"
 Outlet thread: G1/4"

Art. no.81963097



FORMIER PRESSURE REGULATOR 1 FLOWMETER
 High-quality and high-capacity Formier pressure regulator. Max. 200 bar primary pressure. With flowmeter for gas flow read-out.
 Operating range: 0-34 l/min.
 Inlet thread: W21.8x14/1"LH
 Outlet thread: G3/8"LH

Art. no.81963067



ARGON/MIX PRESSURE REGULATOR 2 FLOWMETRES
 Argon/mix pressure regulator. Max. 200 bar primary pressure. With 2 flowmetres for gas flow read-out. Used for shielding gas and back-up gas from the same gas cylinder.
 Operating range: 0-34 l/min.
 Inlet thread: W24.32x14/1"
 Outlet thread: G3/8"

Art. no.81963057



OPTIMATOR TAP UNIT 1 FLOWMETER
 Optimator tap unit with built-in gas-saver. For mounting on stop valves at the welding spot in central systems. Flowmeter with operating range: 0-35 l/min.
 Inlet thread: G3/8"
 Outlet thread: G3/8"

Art. no.81963045



OPTIMATOR TAP UNIT LOCKABLE 1 FLOWMETER
 Lockable Optimator tap unit for Argon with built-in gas-saver. For mounting on stop valves at the welding spot in central systems. Flowmeter with operating range: 0-35 l/min.
 Inlet thread: G3/8"
 Outlet thread: G3/8"

Art. no.81963327



OPTIMATOR TAP UNIT 1 FLOWMETER
 Optimator tap unit with built-in gas-saver. For mounting on stop valves at the welding spot in central systems. Flowmeter with operating range: 0-35 l/min.
 Inlet thread: G3/8"
 Outlet thread: G1/4"

Art. no.81963052



AR/MIX OPTIMATOR FOR RETROFITTING
 Argon/mix Optimator gas-saver. For retrofitting on ordinary pressure regulators or tap units.
 Inlet thread: G3/8"
 Outlet thread: G3/8"

Art. no.81963054



OPTIMATOR ALTOP
 Argon/mix gas saver equipped with quick-release fittings for Altop. Mounting on Altop cylinder does not require additional fittings.

Art. no.81963316

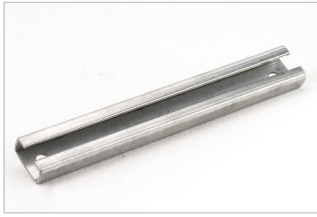

WALL FITTING FOR TAP UNIT
Wall fitting for mounting of stop valves for tap units.

Art. no.81963130



ANGLE PIECE FOR TAP UNIT
Angle piece for mounting tap units. Thread: G3/8"

Art. no. 81963131

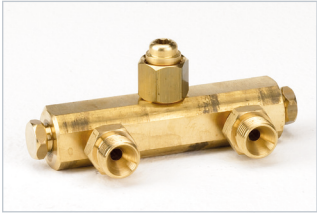

T-PIECE FOR TWIN TAP UNIT
T-piece for mounting of twin tap unit. Thread: G3/8"

Art. no. 81963132



STOP VALVE FOR TAP UNIT
Stop valve for mounting between central system and tap unit. Thread: G3/8"

Art. no. 81963133



LOW-PRESSURE MANOMETER ACETYLENE
Low-pressure 0-4 bar manometer. Spare part for Migatronic acetylene pressure regulator.

Art. no.81963140



HIGH-PRESSURE MANOMETER ACETYLENE
High-pressure 0-40 bar manometer. Spare part for Migatronic acetylene pressure regulator.

Art. no. 81963141



HIGH-PRESSURE MANOMETER CO₂ AND ARGON/MIX
High-pressure 0-315 bar manometer. Spare part for Migatronic CO₂ and Argon/mix pressure regulator.

Art. no.81963144



LOW-PRESSURE MANOMETER CO₂ AND ARGON/MIX
Low pressure manometer. 0-35 l/min. Spare part for Migatronic CO₂ and Argon/mix pressure regulators.

Art. no. 81963145



LOW-PRESSURE MANOMETER OXYGEN
Low pressure manometer 0-16 bar. Spare part for Migatronic oxygen pressure regulator.

Art. no. 81963165



HIGH-PRESSURE MANOMETER OPTIMATOR
High-pressure manometer 0-315 bar. Spare part for Migatronic Optimators.

Art. no.81963127



FLOWMETER TUBE EXTERIOR
Exterior tube for flowmeter tube. For pressure regulators with swivel nut, new model.

Art. no.81963137



FLOWMETER TUBE COMPLETE
Complete flowmeter tube. For pressure regulators with swivel nut, new model.

Art. no. 81963138



FLOWMETER TUBE COMPLETE
Complete flowmeter tube 0-34 l/min. External thread in protective glass. For old models.

Art. no. 81963128



FLOWMETER TUBE EXTERIOR
Exterior tube for flowmeter tube. Exterior thread in glass. For old models.

Art. no.81963173



FLOWMETER
Flowmeter for control of the actual gas flow in the gas nozzle.

Art. no. 81010000



TWIN OUTLET FOR PRESSURE REGULATOR
For two outlets on one Migatronic argon or oxygen pressure regulator with G3/8" thread.

Art. no. 81963149



HOSE NIPPLE WITH SWIVEL NUT 1/4"
Hose nipple with swivel nut. Spare part for Migatronic pressure regulators with G1/4" outlet thread.

Art. no. 81963146



HOSE NIPPLE WITH SWIVEL NUT 3/8"
Hose nipple with swivel nut. Spare part for Migatronic pressure regulators with G3/8" outlet thread.

Art. no. 81963147



SWIVEL NUT GASKETS ARGON/MIX
Swivel nut gaskets in packages of 5 for argon/mix pressure regulators.

Art. no. 81963129



SWIVEL NUT GASKET ACETYLENE
Swivel nut gaskets in packages of five for acetylene pressure regulators.

Art. no. 81963139



FLASHBACK ARRESTOR OXYGEN
Non-resetable flashback arrestor for oxygen which stops and extinguishes backfire. Equipped with safety fuse that shuts off the gas flow in case of overheating.

Art. no. 81963120



FLASHBACK ARRESTOR ACETYLENE
Non-resetable flashback arrestor for acetylene which stops and extinguishes backfire. Equipped with safety fuse that shuts off the gas flow in case of overheating.

Art. no. 81963121

Starter kits, wearing parts boxes etc.

Once you have invested in a Migatronik welding machine, you also need filler materials and wearing parts. **Starter kits help you get started and save money on your total purchase amount.**



STARTER KIT, STAINLESS
 Starter kit for 0.8 mm stainless steel. Applicable for transformer-based Automig welding machines with 2-roll wire feed system. Supplied with 15 kg welding wire, pressure regulator, wire rolls kit and liner.

Art. no.81100121



STARTER KIT, ALUMINIUM
 Starter kit for 1.0 mm aluminium. Applicable for transformer-based Automig welding machines with 2-roll wire feed system. Supplied with 6 kg welding wire, pressure regulator, wire rolls kit, liner and contact tips.

Art. no.81100120



TORCH PROTECTOR
 The torch protector protects torch and central connection on the welding machine against impacts and collisions. For mounting on Migatronik MIG/MAG welding machines with central connection.

Art.no..... 78861400



ADAPTER FOR 5KG WIRE ROLL
 Adaptor for use on the wire hub of the welding machine along with 5 kg/D200 wire spools.

Art. no. 45050333

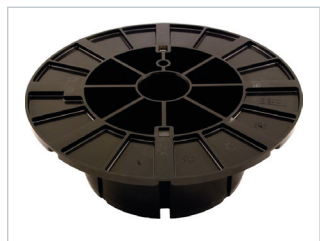

PLASTIC ADAPTER
 Plastic wire adaptor for switch-over between plastic spools (D300) and metal spools (K300).

Art. no.81899017



K4000 GOUGING TORCH
 Gouging torch complete with cable. Total length 220 cm. Classified to 1000 amps. In addition to gouging electrodes, use compressed air along with the hose.

Art. no.81899001



GOUGING ELECTRODES
 Gouging electrodes, 5 x 305 mm. Art. no.81899005
 Gouging electrodes, 6 x 305 mm. Art. no.81899006
 Gouging electrodes, 8 x 305 mm. Art. no.81899008
 Gouging electrod. 9.5 x 305 mm. Art. no.81899010
 Gouging electrod. 12.7 x 305 mm. Art. no.81899013



WEARING PARTS BOX WITH INSERTS
 Wearing parts box with inserts, exclusive of wearing parts. Ideal for storing wearing parts for welding torches.

TIG
 Art. no.81100210

MIG
 Art. no.81100211

WEARING PARTS BOXES

Wearing parts boxes with inserts, including wearing parts. Ideal for storing wearing parts for welding torches.



ML150 steel 0.8 mm
 Art. no.81100223

ML300 steel 1.0 mm
 Art. no.81100232

TIG 101/301/321 2.4-3.2 mm
 Art. no.81100248

ML250 steel 0.8-1.0 mm
 Art. no.81100224

MV450/550 steel 1.0-1.2 mm
 Art. no.81100216

TIG 201/221/401 1.6-2.4 mm
 Art. no.81100230

ML/MV240 steel 0.6-0.8 mm
 Art. no.81100214

MV400 FKS steel 1.0-1.2 mm
 Art. no.81100236

TIG WP24/DSF225 1.6-2.4 mm
 Art. no.81100238

ML/MV240 steel 1.0 mm
 Art. no.81100231

MV500 FKS steel 1.0-1.2 mm
 Art. no.81100237

ZETA 60
 Art. no.81100233

ML/MV240 alu 0.8- 1.2 mm
 Art.nr..... 81100215

TIG 101/301/321 1.6-2.4 mm
 Art. no.81100228

ZETA 100
 Art. no.81100239

Chemicals

Migatronic's chemical products support optimal welding results and comply with the requirements of the law for storage and documentation. 16-point safety data sheets can be downloaded at migatronic.com.



MIG WELDING LIQUID, 10 L
Prevents weld spatter on workpiece and gas nozzle which reduces the need for maintenance of the welding equipment. Concentrated liquid: do not overdose. Supplied in 10 liter cans.

Art.no.....81950034



MIG SPRAY 25 KG SILICONE-FREE
Silicone-free MIG spray refill. Supplied in 25 kg cans.

Art.no.....81950028



MIG PASTE 300 G
Welding and protection paste. Protects gas nozzles against spatter. Made of purely natural products. Silicone-free. Supplied in 300 g cans.

Art.no.....81950026



MIGALUBE 50 ML
Dirt-proof, dust-proof and water-resistant dry lubricant for cleaning of Migatronic plastic feed rolls. The lubricant provides a protective non-drip coating that minimises wear of the movable parts.

Art.no.....99150000



CONCENTRATED COOLANT
Concentrated coolant for frost-proofing below -12° C. Supplied in 1 litre cans.

Ratio:
Temperature / Add concentrate per litre ready-mixed coolant
-21° C / 1 dl
-24° C / 2 dl
-27° C / 3 dl

Art.no.....99290508



GREEN COOLANT 5 LITRES -12° C
Eco-friendly coolant for water-cooled welding machines. Frost-proof down to -12°C. Supplied in 5 litre cans. Use of correct coolant ensures longer life of the welding machine.

Art.no.....99290506



CLEAR COOLANT, 5L -17 ° C
Coolant for water-cooled welding machines with a freezing point of -17 ° C and a conductivity of <math><4\mu\text{S}</math> / cm. The coolant is not flammable and does not require special storage conditions. Delivered in a can of 5 liters.

Art.no.....99290515

Protect your back! Use Miga-Lift and avoid heavy lifting.

MIGA-LIFT

Specially designed robust trolley with large rubber wheels for safe transport of gas cylinders. Use the turning handle to lift the gas cylinder and lower it onto the welding machine. The Miga-Lift is equipped with a self-locking turning mechanism which locks and lifts the gas cylinder in one operation.

Art. no.70619800



Original spare parts

Original Migatronik spare parts ensure correct maintenance and long life of your welding equipment. Below you will find a small selection of our original spare parts. For other recommended spare parts, please refer to spare parts lists/manuals at migatronik.com.

Multi plugs, dinse plugs, earth clamps and electrode holders

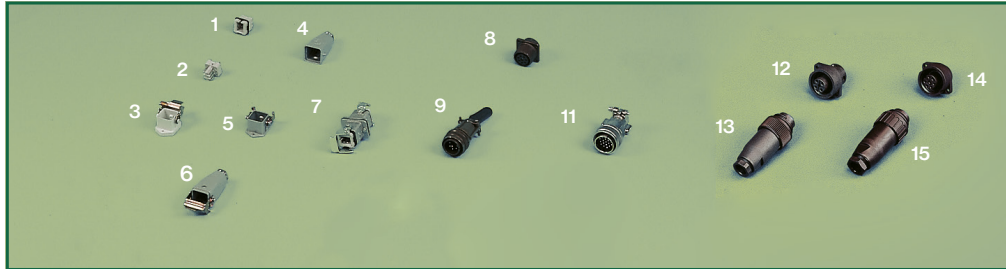

MULTI PLUG 6-POLE

1. Multi plug, female:
Art. no.17200001
2. Multi plug, male:
Art. no.17210001
3. Multiplug housing (plastic)
for mounting on machine
Art. no.18200002

4. Multiplug housing (metal)
for mounting on hose
Art. no.18200101
5. Multiplug housing (metal)
for mounting on machine
Art. no.18200102
6. Extension for metal multiplug
housing for mounting on hose
Art. no.18200103

7. Junction box (metal):
Art. no.74348002

MULTI PLUG 8-POLE

8. Multi plug, female:
Art. no.17200023
9. Multi plug, male:
Art. no.17210024

MULTI PLUG 19-POLE

11. Multi plug, male:
Art. no.17210026

MULTI PLUG 4-POLE

12. Multi plug, female:
Art. no.17200030

13. Multi plug, male:
Art. no.17210030

MULTI PLUG 7-POLE

14. Multi plug, female:
Art. no.17200056

15. Multi plug, male:
Art. no.17210057



DINSE PLUG, MALE

- 10-25 mm² ø10
Art. no.18120006
- 35-50 mm² ø13
Art. no.18120002
- 50-70 mm² ø13
Art. no.18120003
- 70-95 mm² ø13
Art. no.18120004

DINSE COUPLING SOCKET, FEMALE

- 10-25 mm² ø10
Art. no.18110001
- 35-50 mm² ø13
Art. no.18110002
- 50-70 mm² ø13
Art. no.18110003

CURRENT CABLE EXTENSION, FEMALE

- 10-25 mm² ø10
Art. no.18110101
- 35-50 mm² ø13
Art. no.18110102
- 70-95 mm² ø13
Art. no.18110103



MMA ELECTRODE HOLDER

Fully isolating rubber cap. 2 pos. welding angle 45° or 90°. Optimal current transfer. Screw type for optimal electrode grip.

- 200 A Art. no.80550010
- 450 A Art. no.80550009
- 600 A Art. no.80550008

MMA ELECTRODE HOLDER "ALLIGATOR CLIP"

- 300 A Art. no.80550037
- 400 A Art. no.80550035
- 600 A Art. no.80550036
- 200 A Art. no.80550038



SPARE HEAD FOR MMA ELECTRODE HOLDER

- 45/90° 200 A
Art. no.80550027
- 45/90° 450 og 600 A
Art. no.80550028

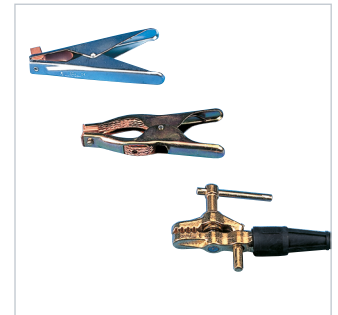

EARTH CLAMP

- 250 A Art. no.80560010
- 400 A Art. no.80560011
- 500 A Art. no.80560012

EARTH CLIP

- 200 A Nevada 200
Art. no.80560001

300 A Nevada 350

- Art. no.80560002

SCREW EARTH CLAMP

- 600 A
Art. no.80560009

Migatronic A/S
Aggersundvej 33
DK-9690 Fjerritslev, Danmark
Tel: (+45) 96 500 600
Telefax: (+45) 96 500 601

www.migatronic.com

MIGATRONIC